

A INDUSTRIAS ALEGRE S.A. COMPANY PROFILE *2019*



Industrias Alegre. S.A. *who we are*

Industrias Alegre is a global full service supplier to the automotive industry expert in managing high technical processes for automotive interiors.

Founded in 1953 by Mr. *Vicente Alegre Tomás*, as a tool making Company for injection plastic parts, has its Head Quarters located in Valencia, Spain.

our vision

To be a global supplier for the automotive interiors growing in the technical products.

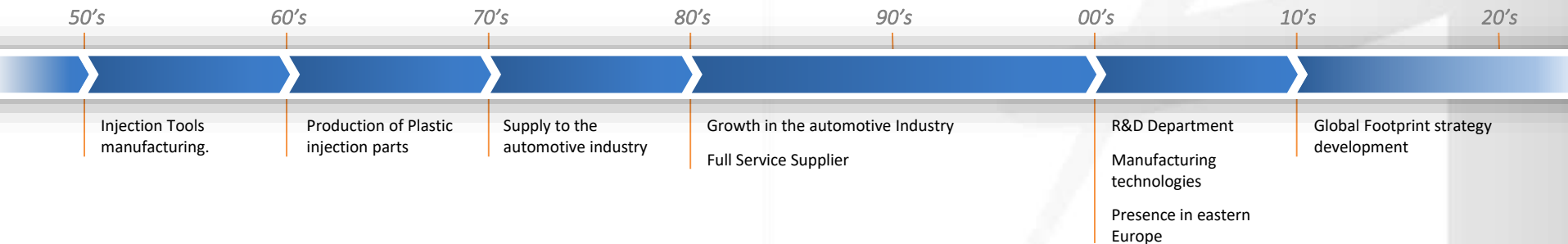

Industrias Alegre. S.A. *business presence*

Western Europe

■ VALENCIA, SPAIN

H.Q. Valencia.

Engineering & Commercial office.

R&D center.

Production plant.

Eastern Europe

■ WROCLAW, POLAND

Production Plant.

■ PITESTI, ROMANIA

Production Plant.

North America

■ DETROIT MI. U.S.

Future engineering &

Commercial office.

Central America

■ PUEBLA, MEXICO

Production Plant.

South America

■ SAO PAULO, BRASIL

Production Plant.

Asia Pacific

■ KANPUR, INDIA

Production Plant.

■ CHENNAI, INDIA

Production Plant.

Morocco

■ Future Poduction Plant.



■ Current Production Facilities

■ Future Production Facilities

■ Planned production Facilities

□ Commercial & engineering Office

□ Future Comm. & Eng. Office

Valencia, Spain

25.000m²
42 Injection machines

*Conventional
Gas assisted
Bi-material
Metal insert/ frame*



Wroclaw, Poland

13.200m²
18 Injection machines (2017)
43 Injection machines (2018)

*Conventional
Gas assisted
Textile Backmoulding
Metal insert*



Pitesti, Romania

6,500m²
20 Injection machines (2017)
56 Injection machines (2018)

*Conventional
Gas assisted
Bi-material
Metal insert
Blowmoulding*



Puebla, Mexico

12.000m²
40 Injection machines

*Conventional
Bi-material*



Kanpur, India

7.500m²
20 Injection machines

*Conventional
Gas assisted
Bi-material
Metal insert*



Chennai, India

4.000m²
12 Injection machines

*Conventional
Gas assisted*



Sao Paulo, Brasil

2.800m²
66 Injection machines

*Conventional
Gas assisted
Bi-material
Metal insert*



Industrias Alegre. S.A. *from concept to production*

optimization process

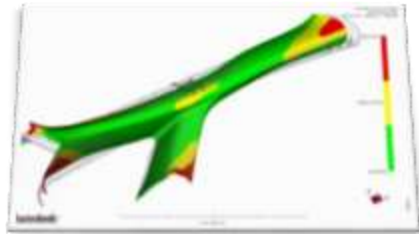

FEA Analysis

Concept & part design

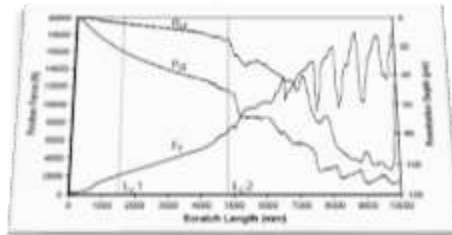

Mold Flow simulation

Prototyping & validation testing

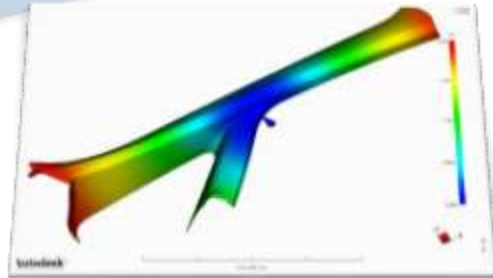

Tooling

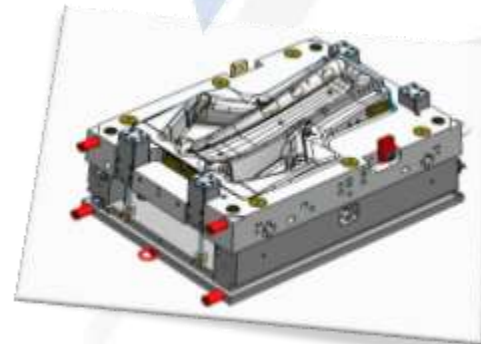

PRODUCTION



Industrias Alegre. S.A. sales evolution

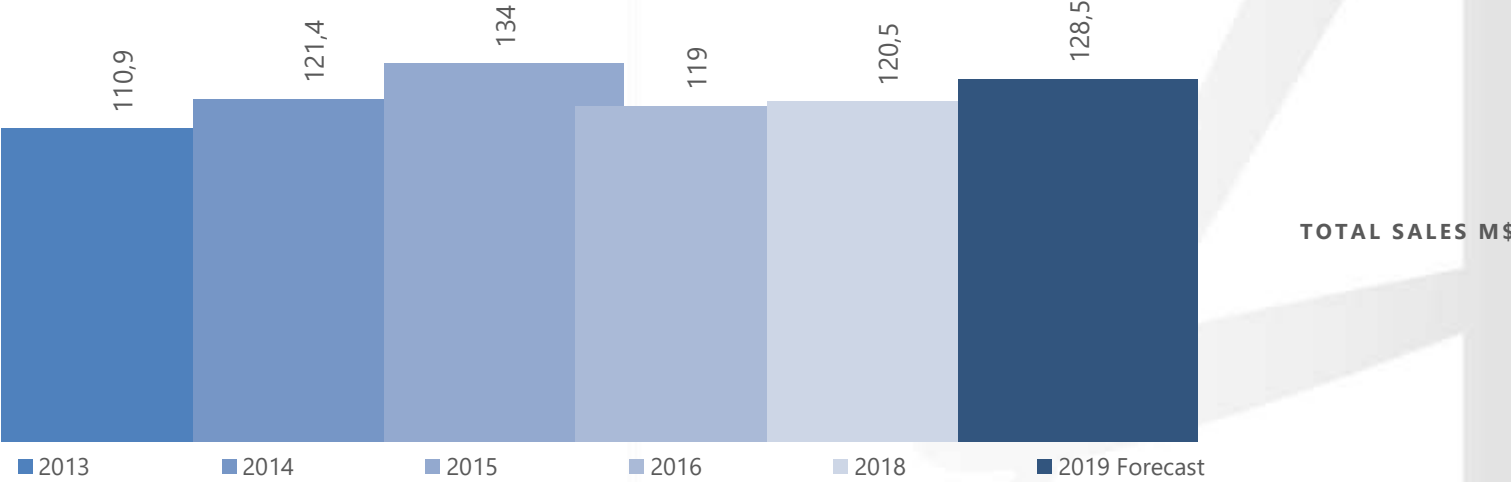

Industrias Alegre. S.A. interior trim components



A Pillar



B Pillar Upper



C/D Pillar Upper



Support Package Tray



Cowl Side



B Pillar Lower



C/Pillar Lower

Industrias Alegre. S.A. interior trim components



Quarter Trim Panel



Back Panel Lower



Tailgate Lower



Tailgate Lower & Grab Handle



Industrias Alegre. S.A. instrument panel components



Instrument Panel Components



Glove Boxes



Center Consoles



Lower Instrument Panel



Industrias Alegre. S.A. *seat components*



Seat Components

Industrias Alegre. S.A. *seat components*



Industrias Alegre. S.A. overhead consoles



Industrias Alegre. S.A. door cappings



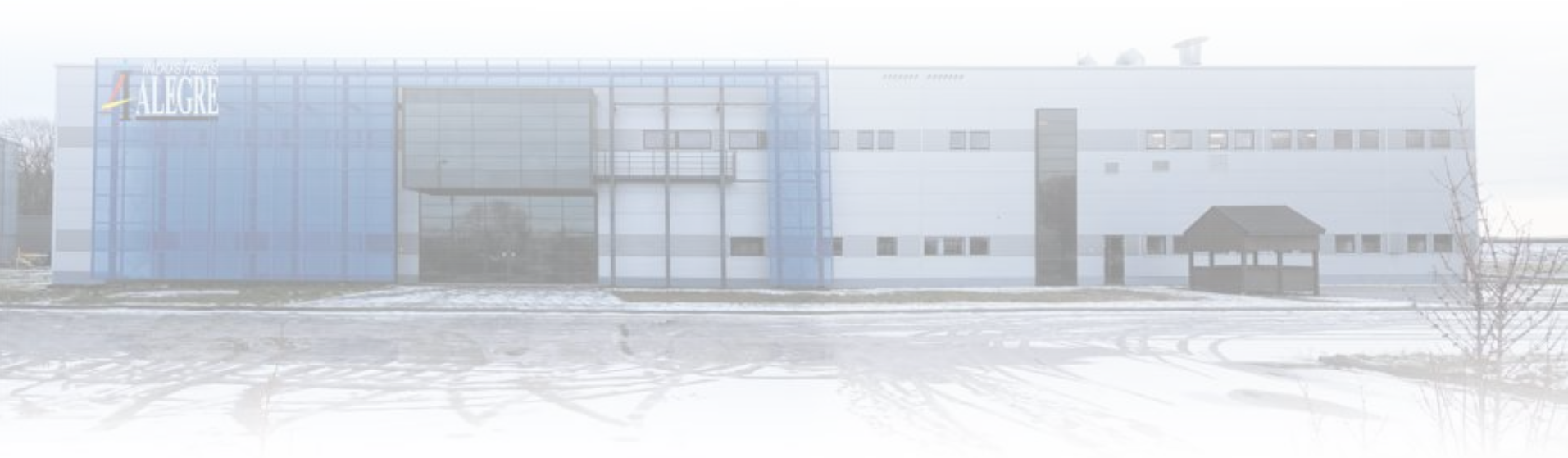

Industrias Alegre. S.A.

Pista de Silla Km.9 46470 Albal - Valencia - Spain T +34 961 220 200 F +34 961 261 400 www.ialegre.com ialegre@ialegre.com